

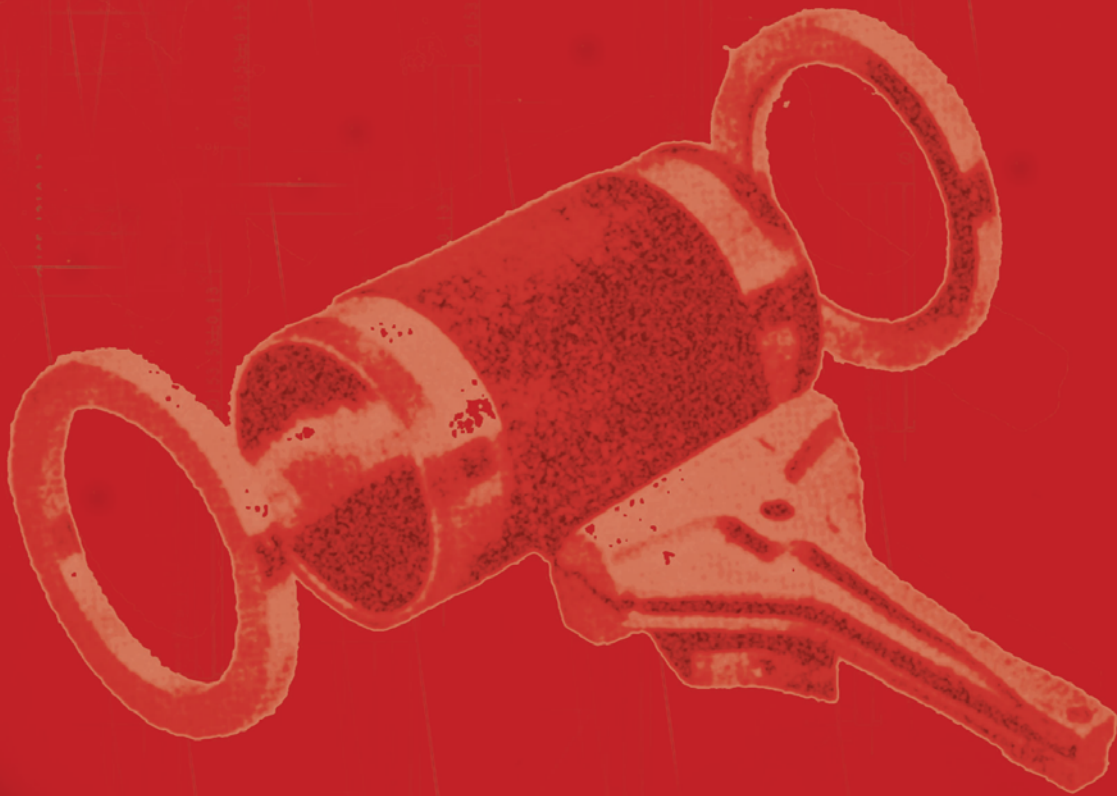

# SUNNEN<sup>®</sup> HONING TECHNIQUES

DATA FILE: #108

FIXTURING PARTS FOR POWER STROKING













[WWW.SUNNEN.COM](http://WWW.SUNNEN.COM)



# CONTENTS

## Part Fixturing Categories

Most parts that you would hone on a Sunnen Power Stroker fall into 10 categories as far as fixturing is concerned. They are:

	1. Parts which have a round outer surface and a substantial wall thickness . . . . .	3
	2. Parts with thin walls . . . . .	3
	3. Parts with projections on the outer surface . . . . .	4
	4. Parts with a hole on the outer surface . . . . .	4
	5. Parts with irregular outer surfaces . . . . .	5
	6. Parts which are too short to be honed one at a time . . . . .	6
	7. Parts with short bores which must be held square to the face . . . . .	7
	8. Parts with blind holes . . . . .	8
	9. Long parts to be honed on one end . . . . .	8
	10. Parts which appear to have no easy way to hold them . . . . .	9
	11. Parts to be externally honed . . . . .	9
	Standard off-the-shelf fixturing Items . . . . .	10

The examples shown in this data file show how parts from each of these categories have been successfully fixtured. With this information, you should be able to apply the principles shown here to the fixturing of your own parts, when necessary.

---

## INTRODUCTION

This book is a general guide on fixturing that may be used with the Sunnen Power Stroker. The photographs and fact sheets provide sufficient information for most shops to design and make a successful fixture in those cases where standard Sunnen off-the-shelf fixturing will not do the job.

### Primary Design Considerations

1. The fixture must absorb the honing torque.
2. The bore must be free to align itself with the mandrel.
3. The fixture must not distort the part.
4. The fixture should permit quick, easy loading and unloading.

## POWER STROKING FIXTURING

### 1. Parts which have a round outer surface and a substantial wall thickness . . .

Use a Sunnen HF-\_\_\_ Loop-Grip Workholder to keep the workpiece from turning. Workholders are available in three sizes; select the size that best accommodates the length and diameter of your part.

On heavy stock removal operations, end thrust from stroking can be absorbed with a KKN-700 Universal Honing Fixture, as shown.

On light honing operations, end thrust from stroking can be absorbed with a KKN-600 Adjustable Finger Fixture and KKN-720A Fingers (*see Category 5*).

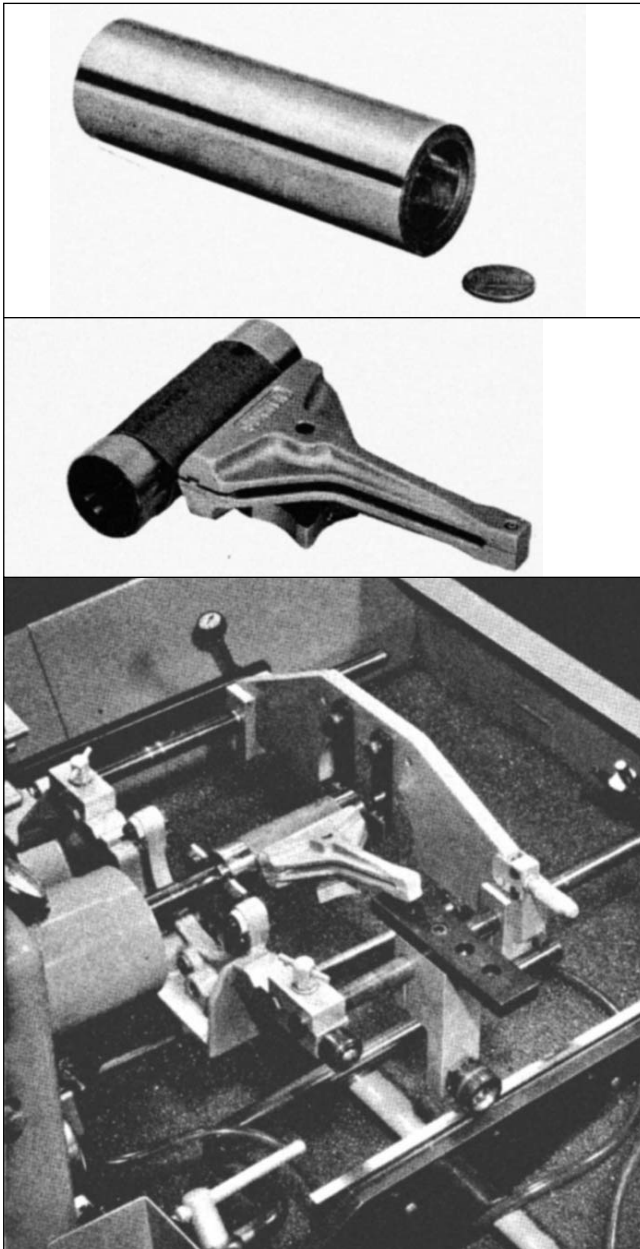

Figure 1, Thick Wall Parts

### 2. Parts with thin walls . . .

Use a Sunnen HF- Loop-Grip Workholder to keep the workpiece from turning. This type of holder is essential to avoid distortion of thin wall parts. Workholders are available in three sizes; select the size that best accommodates the length and diameter of your part.

End cap must be fabricated and put over the ends of the workpiece to give the fingers or face plate a surface to bear upon, as shown.

On heavy stock removal operations end thrust from stroking can be absorbed with a KKN-700 Universal Honing Fixture, as shown.

On light honing operations, end thrust from stroking can be absorbed with a KKN-600 Adjustable Finger Fixture and KKN-720A Fingers (*see Category 5*).

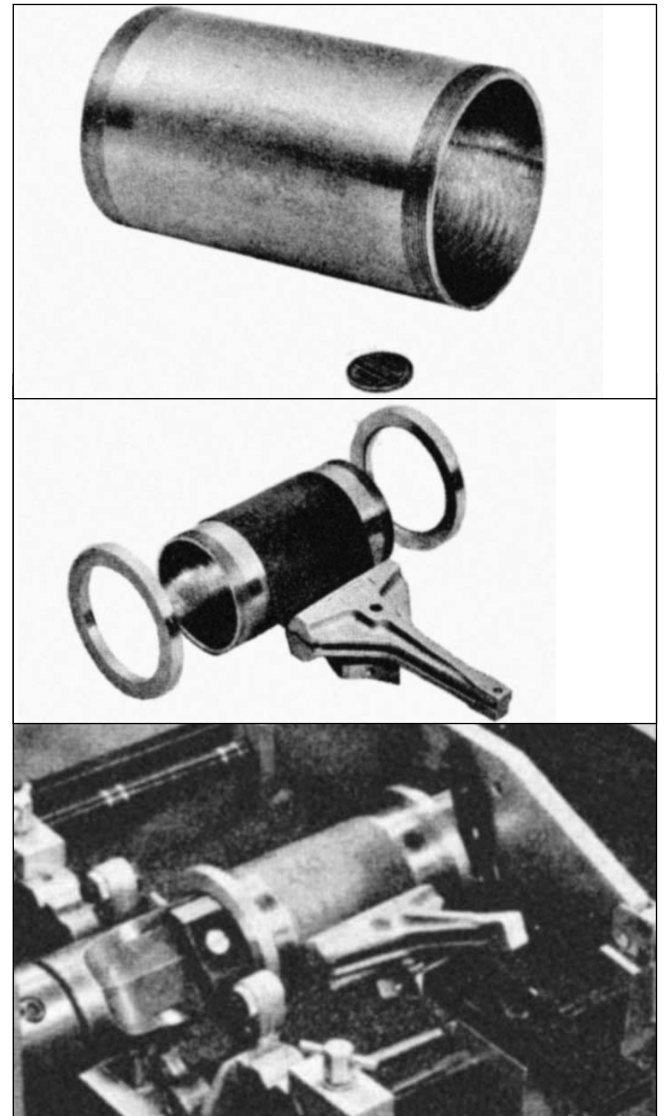

Figure 2, Thin Wall Parts

### 3. Parts with projections on the outer surface . . .

Category 3 parts usually require no workholder; a projection on the part is used to keep the workpiece from turning.

On heavy stock removal operations end thrust from stroking can be absorbed with a KKN-700 Universal Honing Fixture, as shown.

On light honing operations, end thrust from stroking can be absorbed with a KKN-600 Adjustable Finger Fixture and KKN-720A Fingers (*see Category 5*).

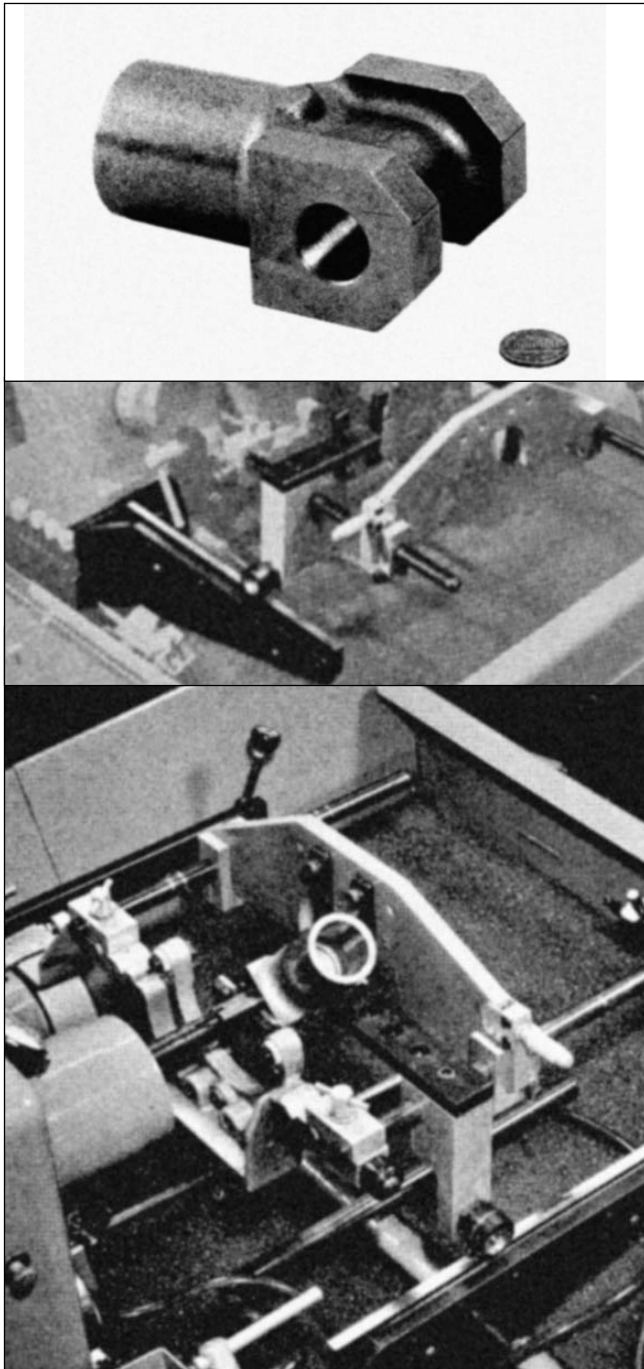

Figure 3, Parts w/Projections

### 4. Parts with a hole on the outer surface . . .

To keep the workpiece from turning, merely stick a rod into the hole.

On heavy stock removal operations end thrust from stroking can be absorbed with a KKN-700 Universal Honing Fixture, as shown.

On light honing operations, end thrust from stroking can be absorbed with a KKN-600 Adjustable Finger Fixture and KKN-720A Fingers (*see Category 5*).

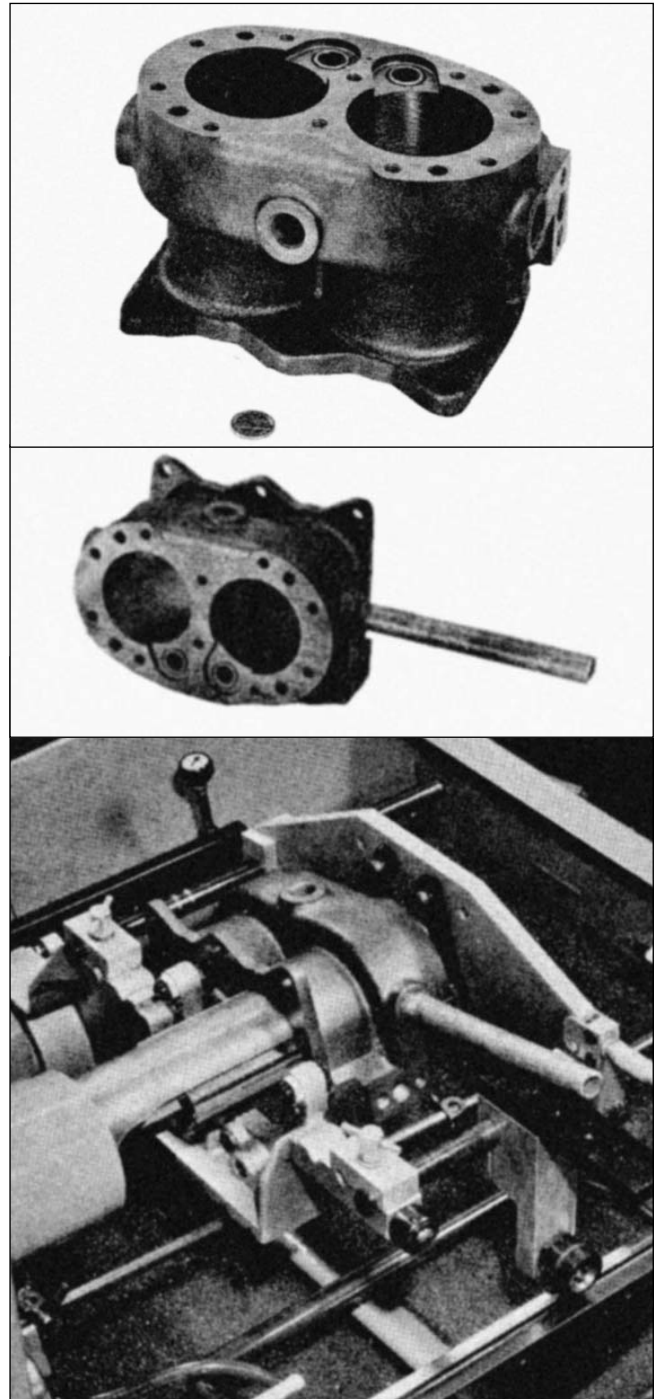

Figure 4, Parts w/Holes

**5. Parts with irregular outer surfaces . . .**

Best method of holding this type of part is to find a flat, a protrusion, a slot, or an indentation on the OD, and fabricate a wrench-type holder to engage the part to keep it from turning, as shown,

On heavy stock removal operations end thrust from stroking can be absorbed with a KKN-700 Universal Honing Fixture (see Category 4).

On light honing operations, end thrust from stroking can be absorbed with a KKN-600 Adjustable Finger Fixture and KKN-720A Fingers, as shown.

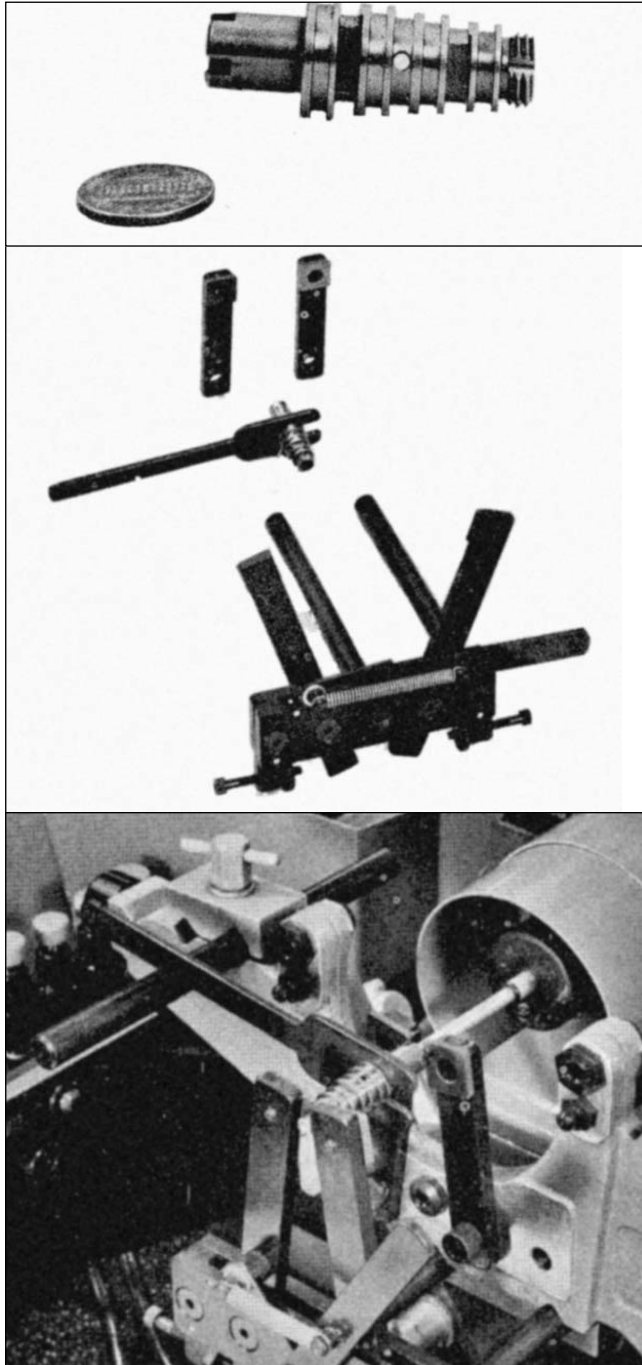

**Figure 5, Parts w/Irregular Surface (1 of 2)**

**6. Parts, which are too short to be, honed one at a time . . .**

Make a pot fixture to accommodate as many parts as can be efficiently honed with the mandrel you will use. A combined part length equal to or longer than stone length is a good place to start. The pot fixture must be open at both ends and should have a screw cap, bayonet, or clamp to contain the parts. A rod is used to keep the pot fixture from turning.

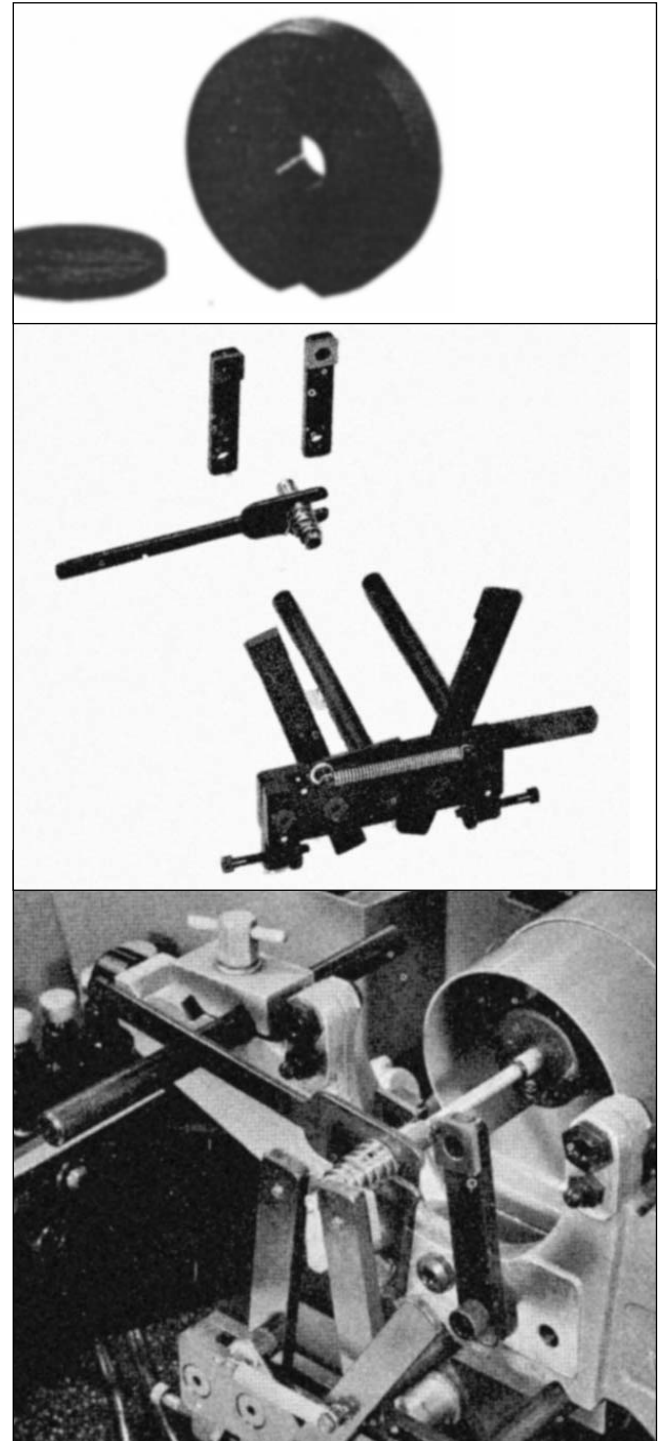

**Figure 5, Parts w/Irregular Surface (1 of 2)**

**CAUTION**

End faces of parts must be flat, parallel, and reasonably square with the bore. I. D. of parts should be lined up so as closely as possible with a plug or expanding mandrel. (A long Sunnen mandrel of the same diameter as you're honing with would be ideal.) Part-to-part variation of rough size should be minimized.

If the parts are shaped so that a convenient way can be found to keep each part from turning individually, lining up and clamping is not necessary. But the stroke must be adjusted so no more than 1/2 the length of the end parts extends beyond the end of the stone at each extreme position of the stroke.

On heavy stock removal operations, thrust is taken on the pot fixture with a KKN-700 Universal Honing Fixture (see Category 8).

On light honing operations, thrust is taken on the pot fixture with a KKN-600 Adjustable Finger Fixture and KKN-720A Fingers, as shown.

**7. Parts with short bores, which must be held, square to the face . . .**

When the diameter of a bore is more than three times its length, and the workpiece has a flat face, Sunnen Power Stroking can create or maintain squareness between the bore and the face. In some cases, this can even be achieved when the diameter of the bore is only twice its length.

Use a Sunnen KKN-\_\_\_\_ faceplate to absorb forward stroke end thrust while keeping the bore square to the face. Configuration of the workpiece will dictate the method to use to keep it from turning.

End thrust on the backstroke can be absorbed with a KKN-700 Universal Honing Fixture, as shown, or with a KKN-600 Adjustable Finger Fixture, (see Category 5). The important thing is that the workpiece must be held flat against the faceplate in order to create or maintain squareness. KKN-615A Flex Pads (available from Sunnen) can often be used to hold the workpiece flat against the face plate, as shown pads should exert pressure on workpiece.

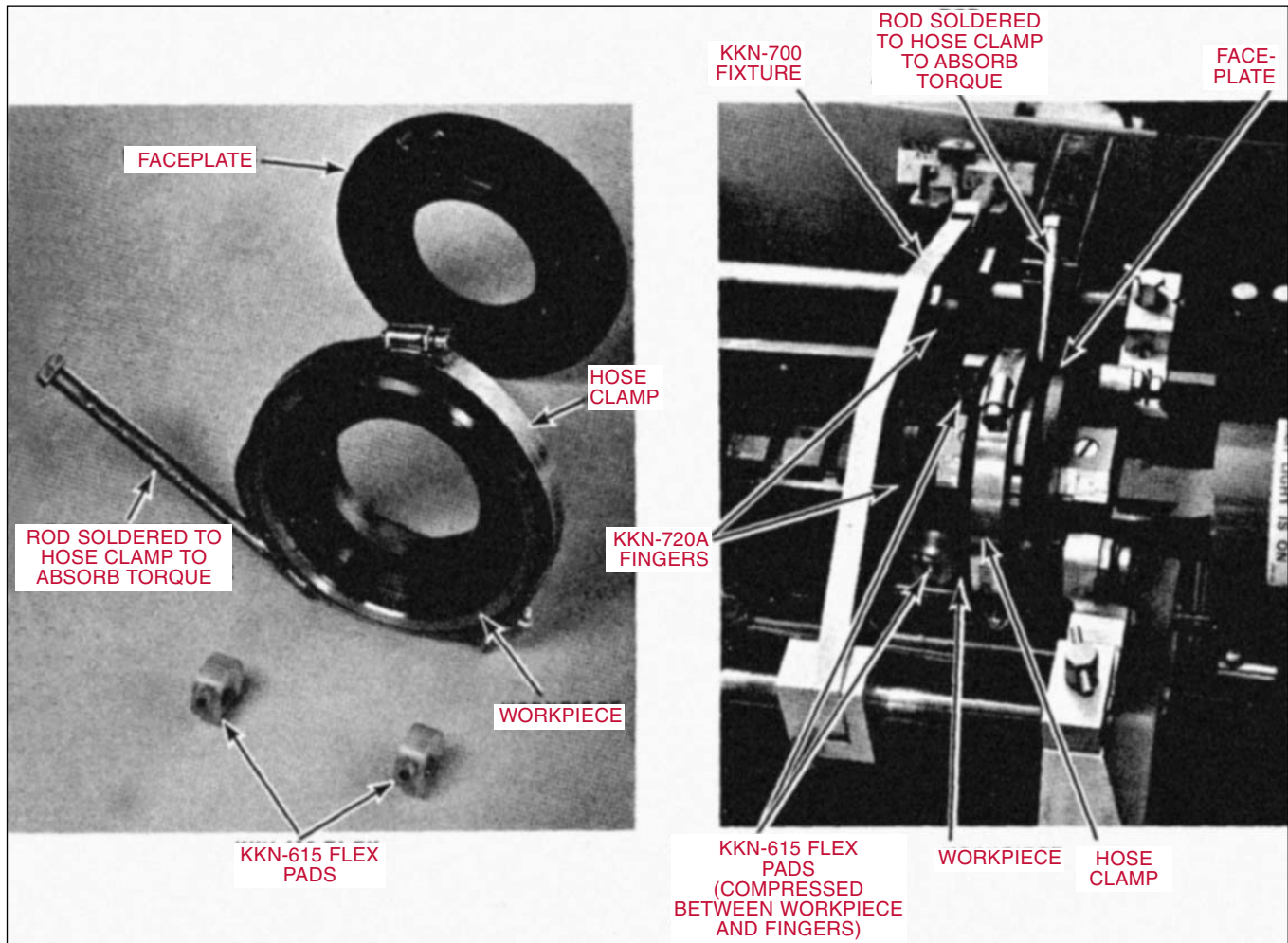

Figure 7, Short Parts w/Sq. Face (1 of 2)

## 8. Parts with blind holes . . .

If at all possible, provide a relief (undercut) at the closed end of the hole to permit the stone to overstroke the honed surface. The relief does not have to be more than a few thousandths deep and can actually blend in with the bore when finish honed, but it should be as long as possible, preferably  $\frac{1}{3}$  the length of the stone.

Sunnen honing units in the K, J-K, AK, J-AK, BL, L, BAL, AL and P28 groups can be utilized for honing bores that have one end closed. (Special Y mandrels can also be made.) In honing blind holes, it is necessary for the stone and guide shoes to extend flush with the tip of the honing unit. If your application utilizes one of the P28 groups of honing units, install the blind hole wedge, blind hole guide shoe and R28 Honing Stones. The remaining mandrel groups have a tip, which extends slightly beyond the front end of the stone and guide shoes. For all blind hole work this tip must be cut off, as illustrated. Mandrels, which have been altered in this manner, can still be used for honing open holes using a full length stone and guide shoes.

The most important thing to remember in fixturing blind-hole parts for power stroking is that the stroke must be longer than the travel of the stone. This sounds incongruous at first, but is accomplished by using a spring in your fixturing . . . the spring permits the stroker arm to continue moving for a short distance after the mandrel has bottomed out in the bore. During this period, the bottom of the bore receives extra honing, called "dwell".

It is necessary to dwell in order to minimize the tightness that results from the inability to overstroke the part at the blind end.

Illustrated on this page is one method of fixturing a blind-hole part . . . note especially the spring, which is the one element that must always be present for successful blind-hole honing.

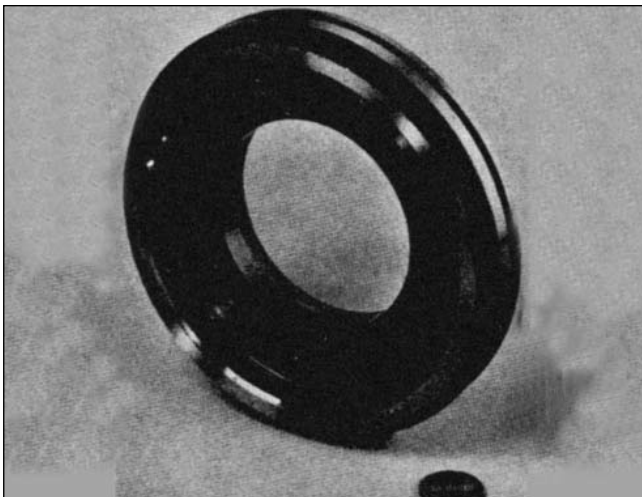
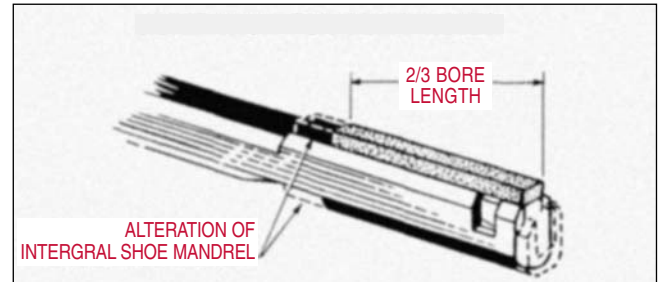

Figure 7, Short Parts w/Sq. Face (2 of 2)



Alteration For Blind Holes

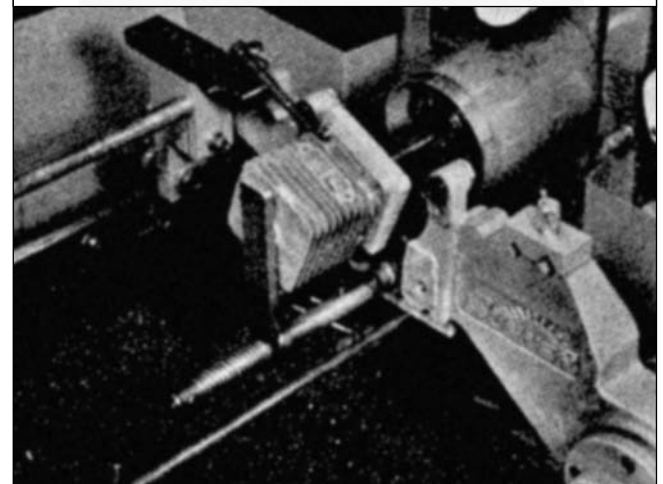
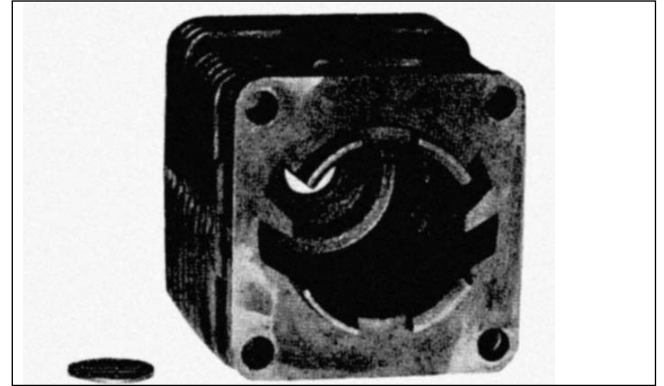

Figure 8, Parts w/Blind Holes

**9. Long parts to be honed on one end . . .**

Long parts which have a short land to be honed on one end must be supported so they don't sag or whip. The fixtures illustrated on this page are designed to clamp onto one of the rods on the KKN-600 Finger Fixture. A rod can be inserted into the clamp on the bottom of the stroking arm if the KKN-600 is not used. The Enclosed Fixture is recommended for production honing, or for high-speed honing where there is a chance for the part to whip.

The Open Fixture is more versatile, accommodating many different ODs. It is very handy to have around a tool room, or-wherever short runs of various parts is the rule.

Dimensions on the drawings are for typical fixtures; vary as needed to suit your particular job.

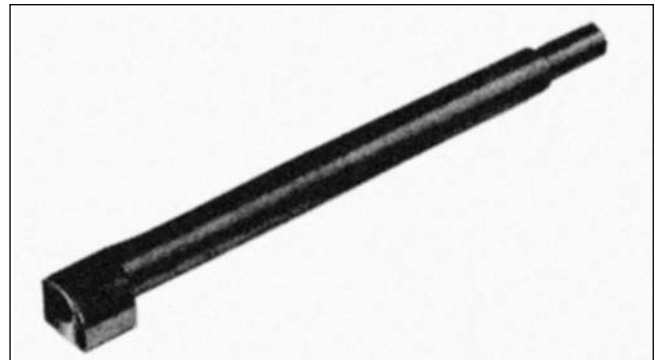

**Figure 9, Long Parts (1 of 4)**

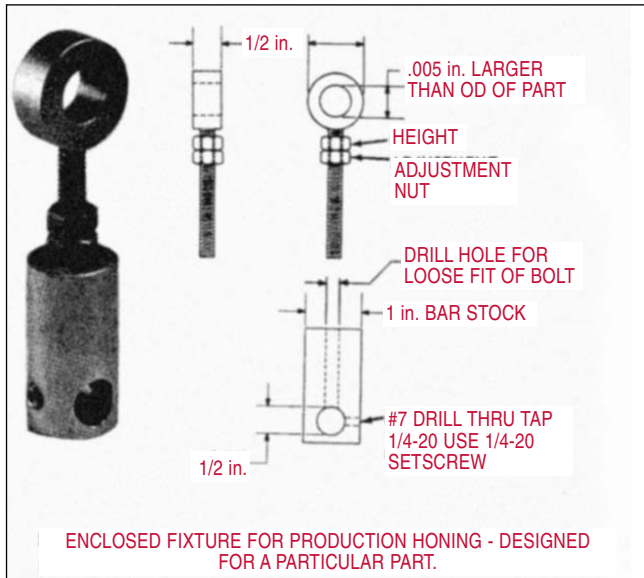

**Figure 9, Long Parts (2 of 4)**

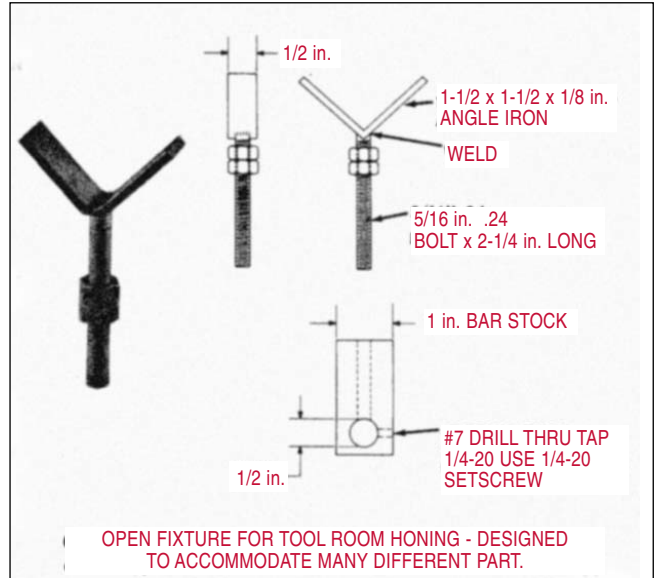

**Figure 9, Long Parts (3 of 4)**

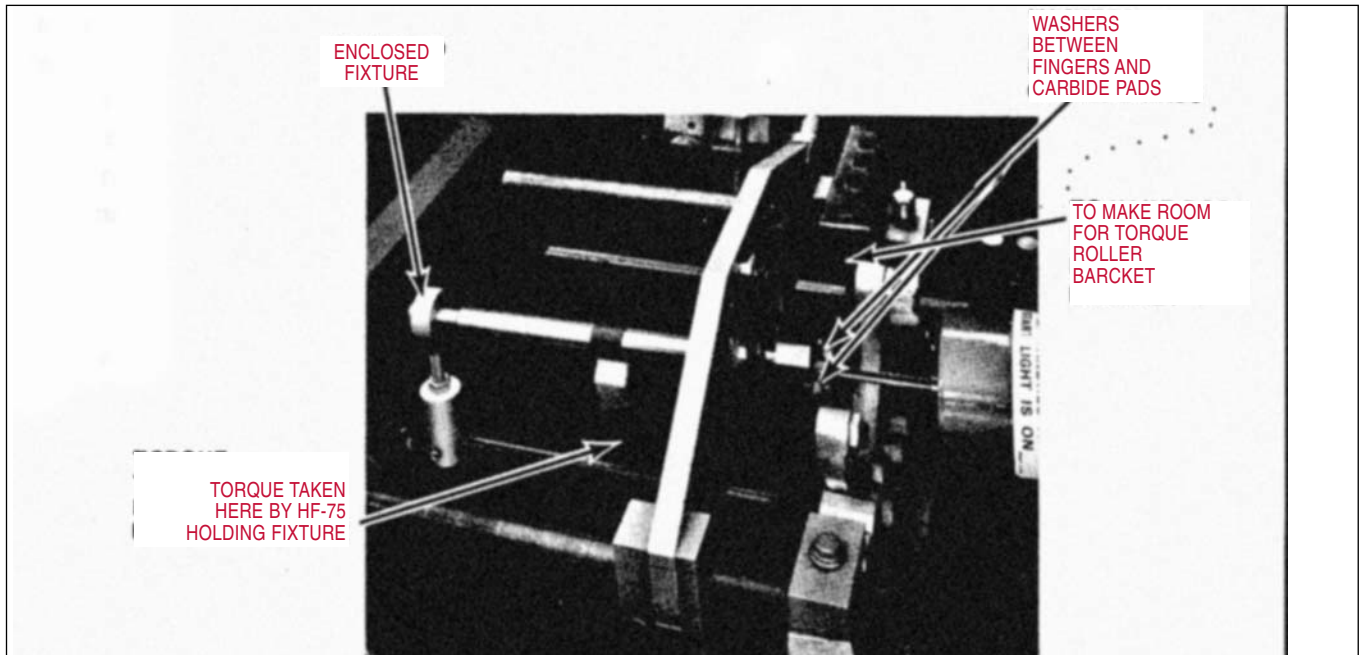

**Figure 9, Long Parts (4 of 4)**



### 10. Parts which appear to have no easy way to hold them . . .

Sometimes you run across a part which cannot be held by any of the preceding methods. The reasons could be varied. In the case illustrated here, the bevel gear to be honed seems to defy any attempt to hold it. Cutting both ends out of an empty tuna fish can and using it as a mold to make a fixture with Devcon Plastic Steel solved this particular fixturing problem. A rod was inserted through a slot in the side of the can and into the fixture before 'it hardened ... the rod to be used to keep the part from turning during honing.

With parts in this category, use your imagination. Just remember that, no matter how odd it looks, there's probably some way to hold it. If you need some ideas, call your nearby Sunnen Man in ... he'll be happy to help.

On heavy stock removal operations end thrust from stroking can be absorbed with a KKN-700 Universal Honing Fixture, as shown.

On light honing operations, end thrust from stroking can be absorbed with a KKN-600 Adjustable Finger Fixture and KKN-720A Fingers (*see Category 6*).

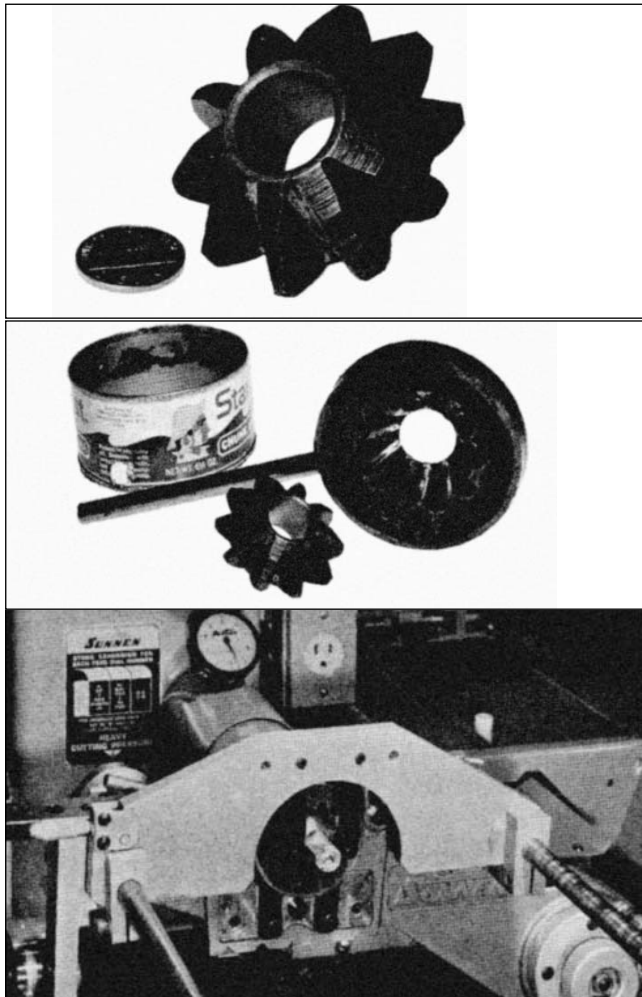

Figure 10, Special Parts

### 11. Parts to be externally honed . . .

Hold the workpiece in an adapter chuck (available from Sunnen) and use the KKN-700 Universal Honing Fixture to stroke the Sunnen External Hone. Four KKN-723A Plain Fingers without carbide pads are included with the KKN-700 for use with the External Hone.



Figure 11, External Honing

**STANDARD OFF-THE-SHELF FIXTURING ITEMS**



KKN-700

**KKN-700 Universal Honing Fixture:** Accommodates almost any workpiece or fixture you'll ever have. Easily and quickly installed or removed. Takes the thrust on forward and backstrokes. Includes two pairs of fingers with longwearing, adjustable carbide pads, and two pairs of driving fingers for use with external hones.



KKN-600

**KKN-600 Adjustable Finger Fixture:** Accommodates most parts; especially useful on small workpieces. Easily and quickly installed or removed. Used in conjunction with KKN-720A Fingers. Includes longwearing, adjustable carbide pads on fingers, two pairs of support rods, and clamp.

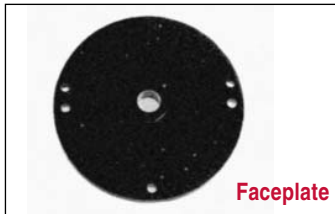

Faceplate

**FacePlates:** Use a face plates on parts whose bore must be kept square to the face. Select correct faceplate from table below. OD of workpiece should be larger than OD of faceplate, and ID of workpiece must be smaller than ID of faceplate. (See Table below.)



KKN-720A

**KKN-720A Fingers:** For fast, economical setups. Long-wearing, adjustable carbide pads. Quick, easy to use. Mount on Stroker Arm. Also used as replacement part for KKN-700. Two per set. Consists of fingers, pads, attaching screws and washers.



KKN-723A

**KKN-723A Finger Set:** For external honing, included with KKN-700 Universal Honing Fixture. KKN-723A Finger Set includes four fingers without carbide pads, and four screws.

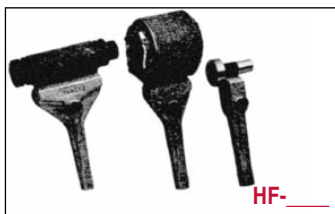

HF-\_\_\_

**Loop-Grip Workholder:** Especially useful for hard-to-hold parts such as thinwall tubes, glass barrels, small parts with smooth surfaces, and parts with sharp projections such as gears and milling cutters. Uses emery cloth to hold part securely without distortion. Parts can be inserted and removed easily. Each fixture handles. (See Table below.)

OUTSIDE DIAMETER RANGE OF WORKPIECE FACE (Inches)	MAXIMUM INSIDE DIAMETER OF WORKPIECE (Inches)	FACE PLATE
.345- .380	.200	KKN-201
.380- .460	.230	KKN-202
.460- .575	.290	KKN-203
.575- .730	.380	KKN-204
.730- .925	.510	KKN-205
.925-1.160	.650	KKN-206
1.160-1.430	.820	KKN-207
1.430 - 1.740	1.030	KKN-208
1.740 - 2.090	1.270	KKN-209
2.090 - 2.480	1.540	KKN-210
2.480 - 2.820	1.850	KKN-211
2.820 - 3.190	2.190	KKN-212
3.190 -and over	2.560	KKN-213
Setup Faceplate		KKN-265

FIXTURE PART NUMBER (INCLUDES 3FT. OF EMERY CLOTH)	EMERY CLOTH	REPLACEMENT EMERY CLOTH (25FT. LENGTH)
HF-75	3/4" WIDE	HF-110
HF-200	2" WIDE	HF-210
HF-300	3" WIDE	HF-310
HF-55	Set of all three fixture listed above.	

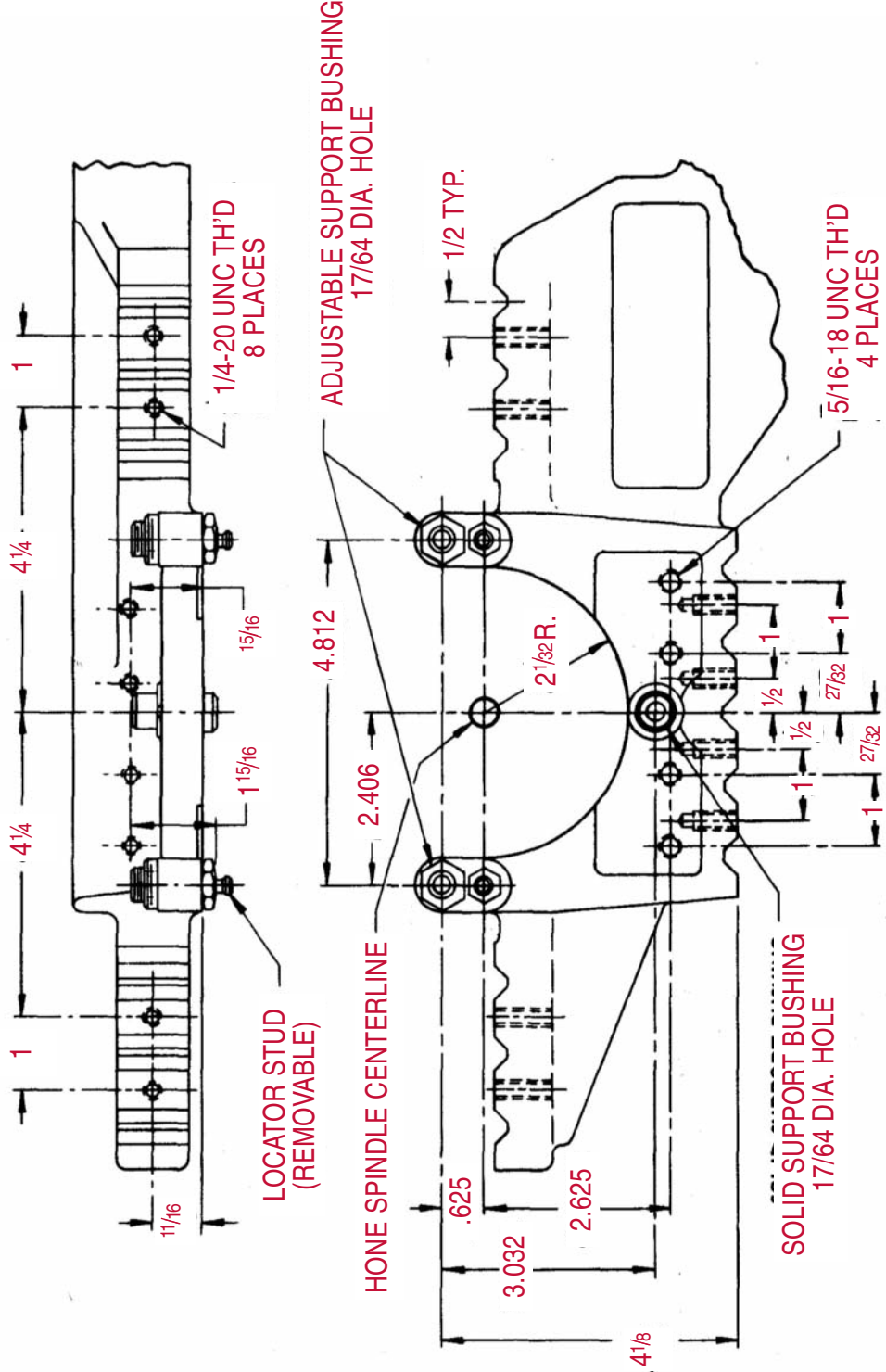

FIXTURING DIMENSIONS

## data files

- 101 - Honing Bores With Keyways And Splines
- 102 - Honing Short Bores
- 103 - Honing Blind Holes
- 104 - Obtaining Specified Finishes By Honing
- 105 - Choosing the Right Stone
- 106 - Honing Tandem Holes
- 107 - Making Manual Honing Easier With Workholders
- 108 - Fixturing Parts For Power Stroking
- 109 - Vertical Hone Fixture
- 110 - Honing Small Bores
- 111 -
- 112 - External Honing
- 113 - Fixturing Design Considerations For Automatic Crossgrinding® Machines

### SUNNEN CUSTOMER SERVICE AND TECHNICAL SERVICE CENTERS

The fully equipped Automotive and Industrial Technical Service Centers in St. Louis is available to help with any honing problem at any time without cost or obligation. Sunnen factory-trained Field Service Engineers cover the entire country and are always at your service - again, no cost or obligation. Call us whenever you have a bore-sizing problem.

VISIT

**WWW.SUNNEN.COM**

"SUNNEN", THE SUNNEN LOGO, GENERAL HONE AND THE GENERAL HONE LOGO ARE REGISTERED TRADEMARKS OF SUNNEN PRODUCTS COMPANY."

## SUNNEN WORLDWIDE

*A LEGACY OF EXCELLENCE SINCE 1924.*

### Sunnen Products Company

World Headquarters  
St. Louis, MO – USA  
Phone 1.314.781.2100  
Fax 1.314.781.2268  
Toll Free 1.800.325.3670  
Email [sunnen@sunnen.com](mailto:sunnen@sunnen.com)  
[www.sunnen.com](http://www.sunnen.com)

### Switzerland – Sunnen AG

Phone +41 71 649 33 33  
Fax +41 71 649 33 34  
Email [info@sunnen.ch](mailto:info@sunnen.ch)  
[www.sunnen.ch](http://www.sunnen.ch)

### Italy – Sunnen Italia S.r.l.

Phone +39 02 383 417 1  
Fax +39 02 383 417 50  
Email [sunnen@sunnenitalia.com](mailto:sunnen@sunnenitalia.com)  
[www.sunnenitalia.com](http://www.sunnenitalia.com)

### France – Sunnen SAS

Phone +33 01 69 30 0000  
Fax +33 01 69 30 1111  
Email [info@sunnen.fr](mailto:info@sunnen.fr)  
[www.sunnen.fr](http://www.sunnen.fr)

### UK – Sunnen Products Ltd.

Phone +44 1442 39 39 39  
Fax +44 1442 39 12 12  
Email [hemel@sunnen.co.uk](mailto:hemel@sunnen.co.uk)  
[www.sunnen.co.uk](http://www.sunnen.co.uk)

### Poland – Sunnen Polska Sp. z o.o.

Phone +48 22 814 34 29  
Fax +48 22 814 34 28  
Email [sunnen@sunnen.pl](mailto:sunnen@sunnen.pl)  
[www.sunnen.pl](http://www.sunnen.pl)

### Russia – Sunnen RUS

Phone +7 495 258 43 43  
Fax +7 495 258 91 75  
Email [sunnen@sunnen-russia.ru](mailto:sunnen@sunnen-russia.ru)  
[www.sunnen.ru](http://www.sunnen.ru)

### Czech Republic – Sunnen s.r.o.

Phone +420 383 376 317  
Fax +420 383 376 316  
Email [sunnen@sunnen.cz](mailto:sunnen@sunnen.cz)  
[www.sunnen.cz](http://www.sunnen.cz)

### China – Shanghai Sunnen Mechanical Co. Ltd.

Phone +86 21 5813 3990  
Fax +86 21 5813 2299  
Email [shsunnen@sunnensh.com](mailto:shsunnen@sunnensh.com)  
[www.sunnensh.com](http://www.sunnensh.com)

Sunnen® reserves the right to change or revise specifications and product design in connection with any feature of our products contained herein. Such changes do not entitle the buyer to corresponding changes, improvements, additions, or replacements for equipment, supplies or accessories previously sold. Information contained herein is considered to be accurate based on available information at the time of printing. Should any discrepancy of information arise, Sunnen recommends that user verify the discrepancy with Sunnen before proceeding.

©2009 Sunnen Products Company Printed in USA  
DF-108 9/09 - POD